

# Not Necessarily A Gibson, But A Flying V Nontheless

created/diagrammed by Alec Feil 7/25/00

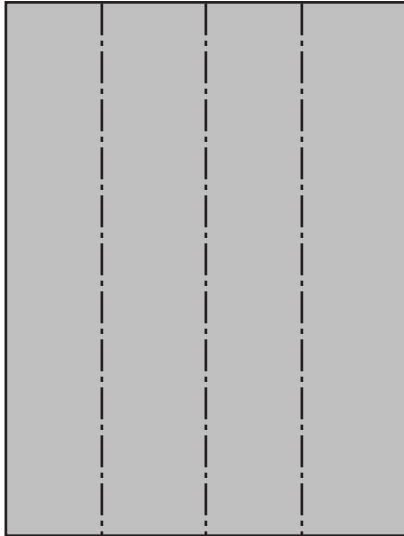

1] 2x3 rectangle.  
Precrease mountains.

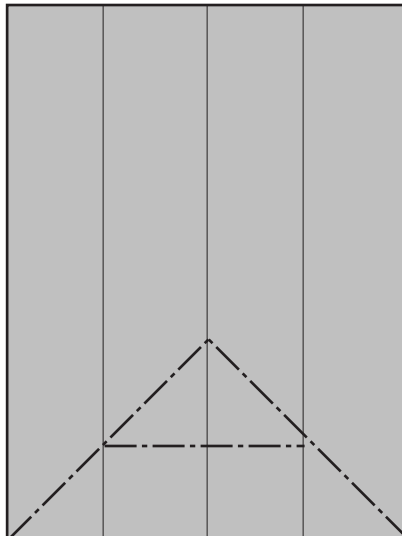

2] More precreases.

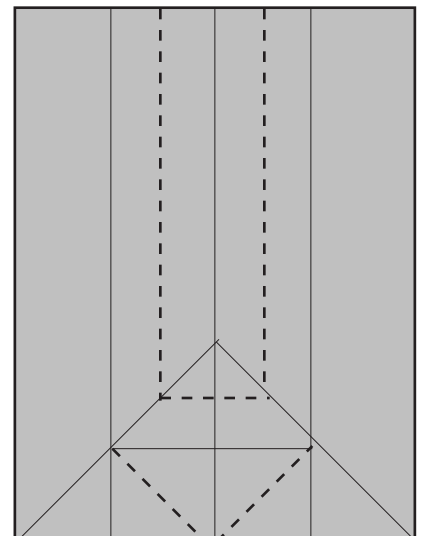

3] More precreases.

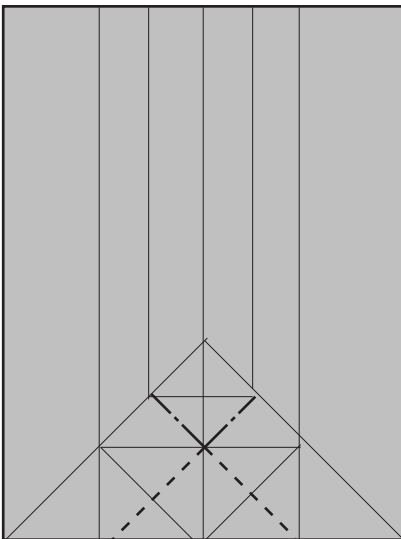

4] More creases. Note the top creases are mountains while the bottoms are valleys.

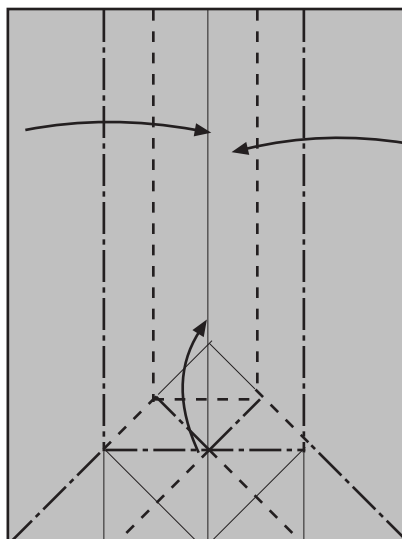

5] Collapse. Begin by pinching corners, then allow bottom to form a point and move up, and finally folding left and right edges over.

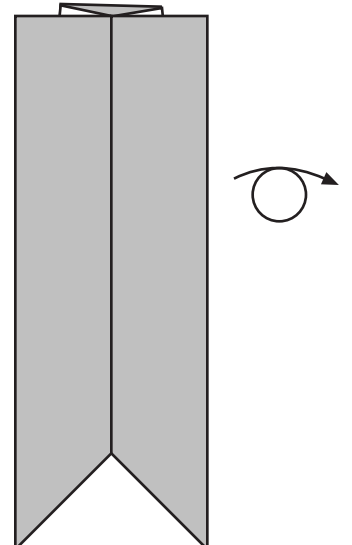

6] Turn over.

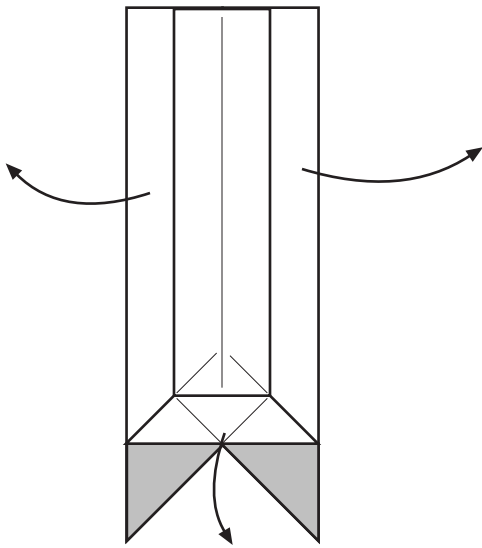

7] Unfold, but do not flatten!

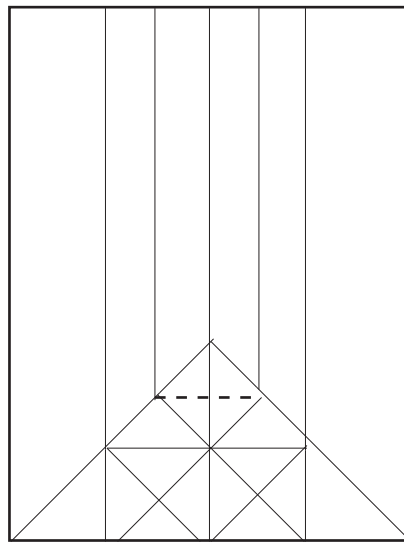

8] Change one mountain to a valley.

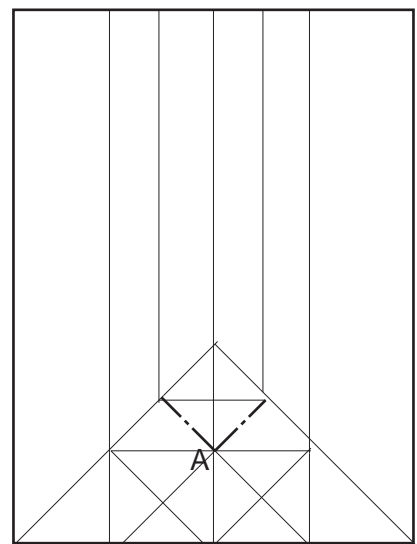

9] Define 2 mountains on existing creases and pop point A so it points up.

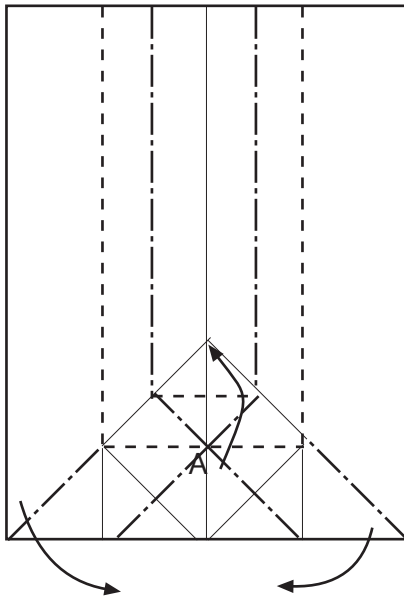

10] Collapse and form water bomb on point A.

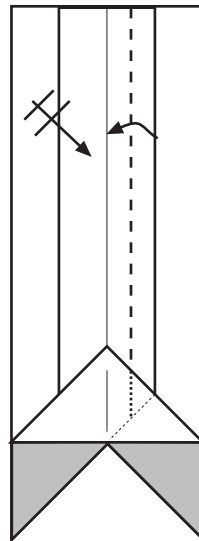

11] Fold flap in half. Repeat on left.

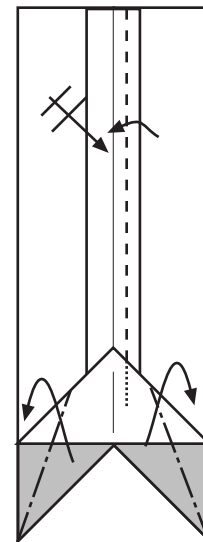

12] Fold in half again. Bisect top layer. Tuck behind.

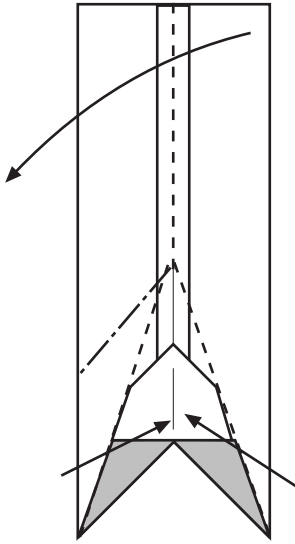

13] Rabbit ear. Be careful not to allow paper to slip.

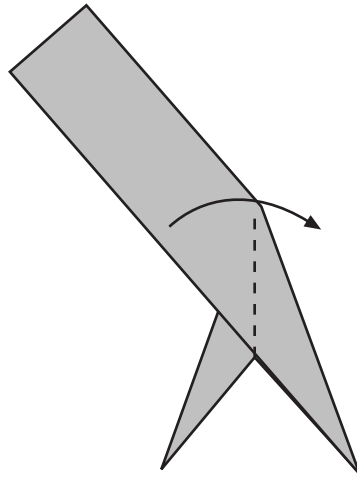

14] Fold top layer over. Include small flap inside. Model will not lay flat.

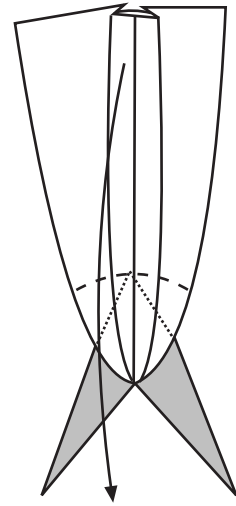

15] Flatten.

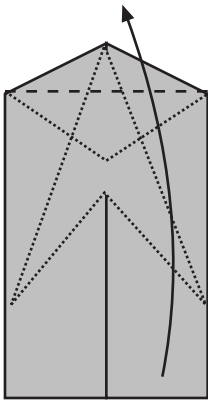

16] Valley top flap up.

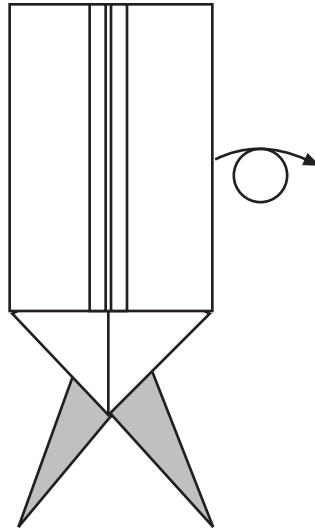

17] Flip over.

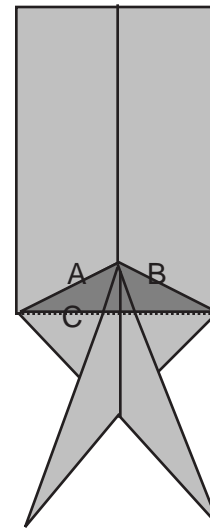

18] Sink the darker region (bring large rectangle to front). This is easiest if you unfold a little first. Turn ridges A and B into valleys and turn x-ray crease C into a mountain, then re-collapse.

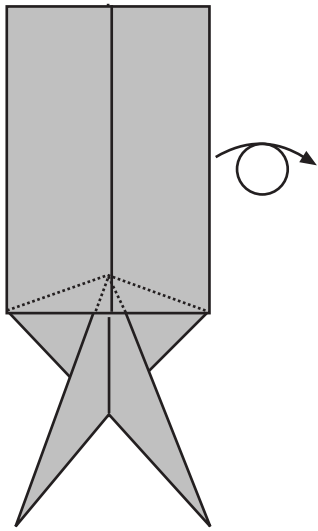

19] Flip over.

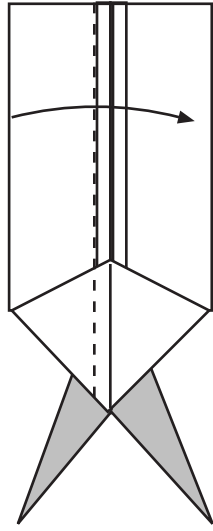

20] Fold flap over.  
Note valley is at edge of flap.

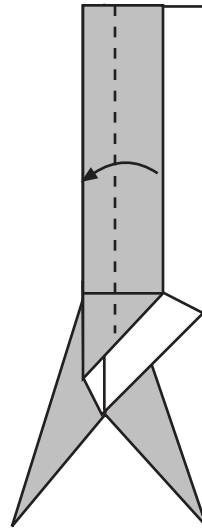

21] Valley over to line up with small flap underneath.

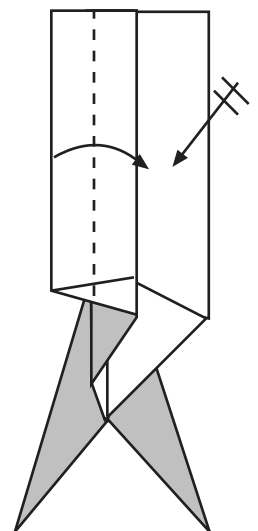

22] FOLD in half.  
Repeat 20-21 on right.

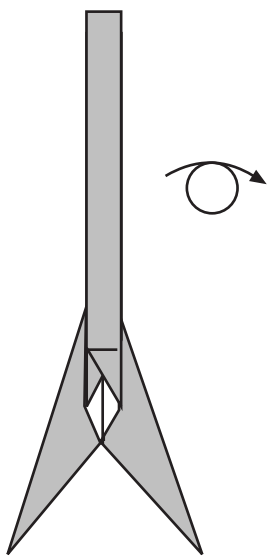

23] Flip over.

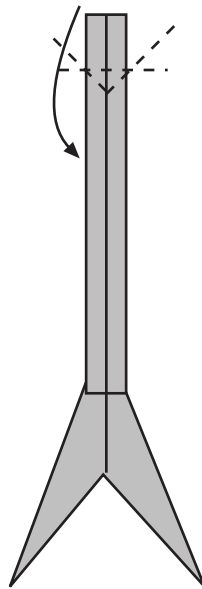

24] Fold tip down while spreading top layer.

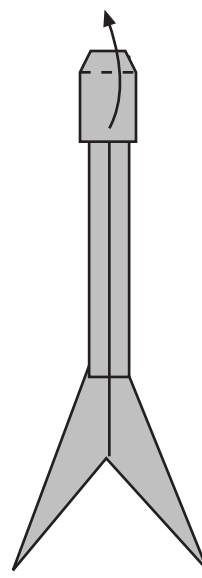

25] Fold up.

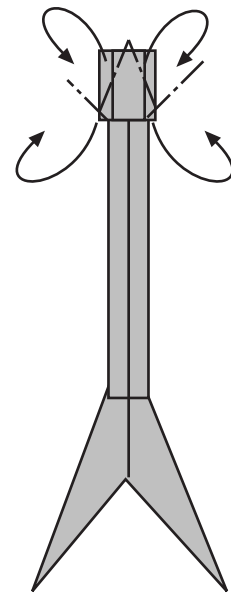

26] Shape headstock with 4 mountains.

